

# POTAIN

## Igo 32

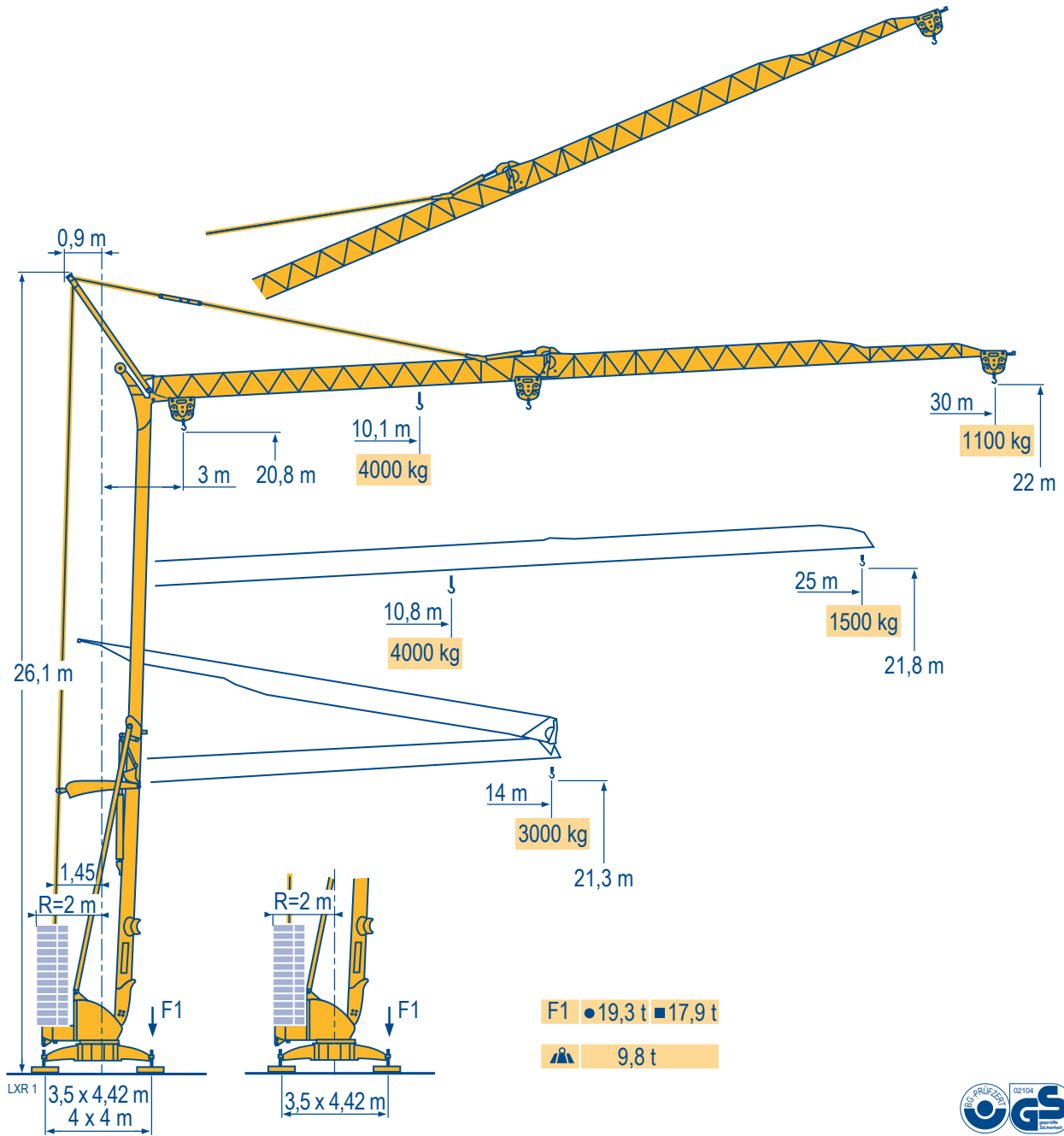

**CE** FEM 1.001-A3

Courbes de charges  
Lastkurven  
Load diagrams  
Curvas de cargas  
Curve di carico  
Curva de cargas

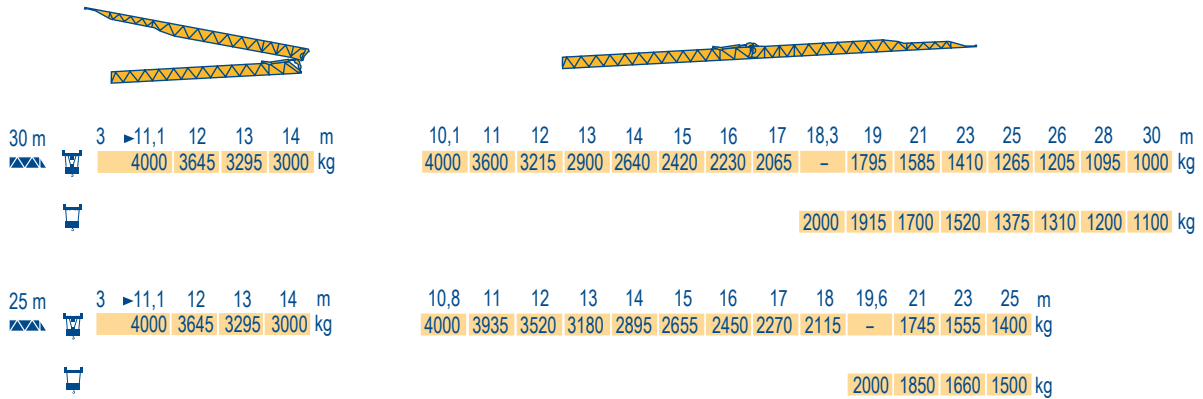

Flèche relevée  
Ausleger in Steilstellung  
Luffing jib  
Flecha izada  
Braccio impennato  
Lança inclinada

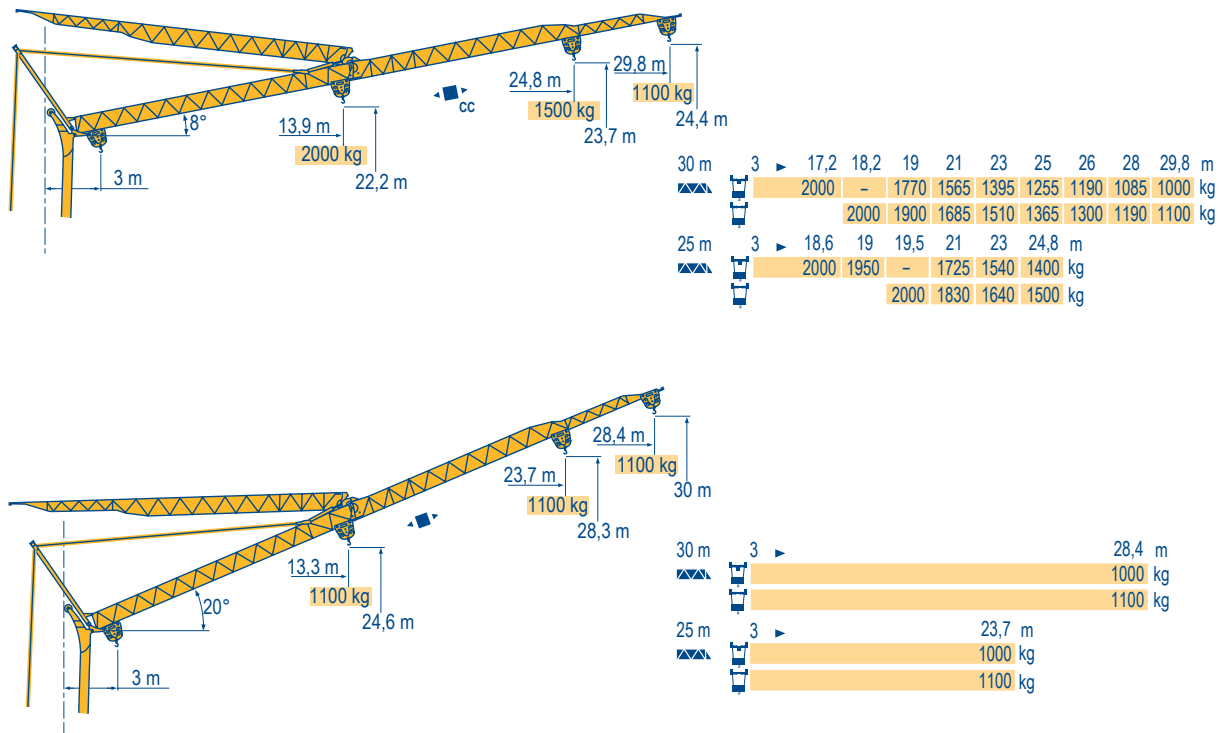

## Igo 32

**POTAIN**



**F**  
Chariot distributeur  
Chariot distributeur et courbes de charges



Réactions en service  
Réactions hors service  
A vide sans lest (ni train de transport) avec flèche et hauteur maximum.



Ohne Last, Ballast (und Transportachse), mit Maximalausleger und Maximalhöhe.



Without load, ballast (or transport axes), with maximum jib and maximum height.



A vuoto, senza zavorra (ne assali di trasporto) con braccio massimo e altezza massima.



Sem carga (nem trem de transporte)- sem lastro com lança e altura máximas.

**D**  
Verfahrbare Laufkatze  
Verfahrbare Laufkatze und Lastkurven

Reaktionskräfte in Betrieb  
Reaktionskräfte außer Betrieb

**GB**  
Traversing trolley  
Traversing trolley and load diagrams

Reactions in service  
Reactions out of service

**E**  
Carro distribuidor  
Carro distribuidor y curvas de cargas

Reacciones en servicio  
Reacciones fuera de servicio

**I**  
Carrellino distributore  
Carrellino distributore e curve di carico







Reazioni in servizio  
Reazioni fuori servizio

**P**  
Carro distribuidor  
Carro distribuidor e curva de cargas

Reacções em serviço  
Reacções fora de serviço

Mécanismes  
Antriebe  
Mechanisms  
Mecanismos  
Meccanismi  
Mecanismos

LXR 2

												ch - PS hp	kW		
	15 LVF 10 Optima	m/min	3,6	18	30	49	66						15	11	
		kg	2000	2000	2000	1100	500								
		m/min	3,6	18	30	54	66	1,8	8,9	15	27	33			
		kg	2000	2000	2000	1000	500	4000	4000	4000	2000	1000			
	3 DVF5	m/min	19 - 41									3	2,2		
	RVF+31	tr/min U/min rpm	0 → 0,8									3	2,2		
		CEI 38		IEC 38											
		400 V (+6% -10%) 50 Hz					15 LVF 10 : 20 kVA								

15 LVF 10  
Optima

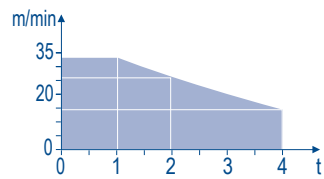

Montage  
Montage  
Erection  
Montaje  
Montaggio  
Montagem

LXR 1

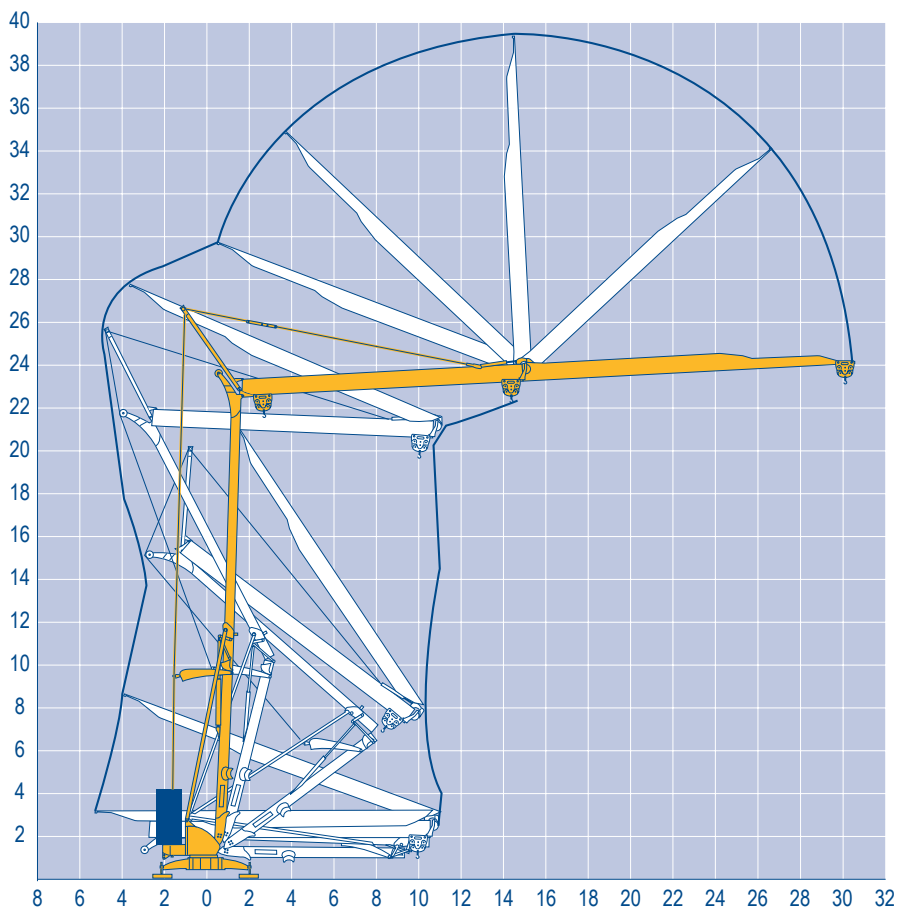

Igo 32

**POTAIN** 

**F**

  
 Levage  
  
 Distribution  
  
 Orientation

**D**

Heben  
 Katzfahren  
 Schwenken

**GB**

Hoisting  
 Trolleying  
 Slewing

**E**

Elevación  
 Distribución  
 Orientación

**I**

Sollevamento  
 Distribuzione  
 Rotazione

**P**

Elevação  
 Distribuição  
 Rotação

Transport  
Transport  
Transport  
Transporte  
Trasporto  
Transporte

LXR 2

		L (m)	B (m)	C (m)	D (m)	H (m)
DS61/S120	○					
DS61/S125	DS61/S120	15,9	2,45	4	6,81	3,05/3,2
DJ80/S120	○					
DJ80/S125	DS61/S125	15,9	2,45	4	6,81	3,05/3,2
DJ100/S120	DJ80/S120	15,9	2,45	4	6,81	3,1
DJ105/S125	DJ80/S125	15,9	2,45	4	6,81	3,1
DJ126M/S215M	DJ100/S120	16,33	2,45	4	6,81	3,1/3,23
	DJ105/S125	16,33	2,45	4	6,81	3,1/3,23
	DJ126M/S125	16,35	2,45	4	6,81	3,2
	DJ126M/S215M	17,14	3,24	4,07	6,74	3,55
DJ126M/S125						
DJ126M/S215M						

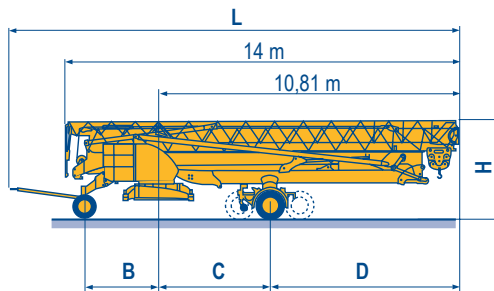

		C (m)	D (m)
SL122/J215M			
SL121/J135	SL122/J215M	4,07	6,74
SL121/S215M	SL121/J135	4	6,81
	SL121/S215M	4,07	6,74

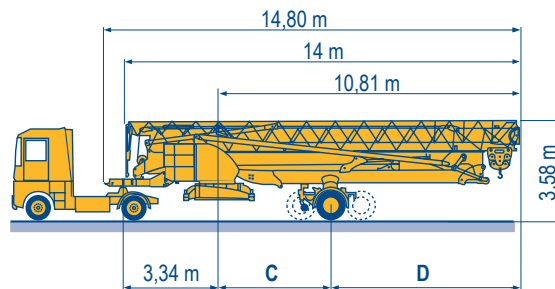

	F	D	GB	E	I	P
○	Chantier	Baustelle	Site	Obra	Cantiere	Estaleiro



Document commercial non contractuel. Pour toute information technique se référer à la notice correspondante.

Unverbindliches Vertriebsdokument. Für technische Informationen, siehe die entsprechenden Anweisungen.

This commercial document is not legally binding. For any technical information, please refer to the corresponding instructions.

Documento comercial non contractuel. Para cualquier información técnica, ver la noticia correspondiente.

Documento commerciale non vincolante, per tutte le informazioni tecniche fare riferimento al catalogo istruzioni.

Documento comercial não contratual. Para qualquer informação técnica complementar consultar as respectivas instruções.



18, rue de Charbonnières - B.R.173  
69132 ECULLY Cedex - France

Tél. : +33 (0) 4 72 18 20 20  
Fax. : +33 (0) 4 72 18 20 00  
www.manitowoccrane.com



Americas  
Tel : +1 888 479 7278  
Tel : +1 717 593 2000

Europe - Middle East - Africa  
Tel : +33 (0) 4 72 81 50 00  
Tel : +44 (0) 191 522 2000

Asia - Pacific  
Tel : +65 6264 1188  
Fax : +65 6862 4142

www.manitowoccrane.com

Igo 32  
Réf. 2003 48 LXR 3

Copyright.Reproduction interdite © POTAIN 2003

Réalisation Secdoc